

Manufactured Housing Installation Instructions

Provided by

TIE DOWN ENGINEERING

(Revised: 5/7/2015)

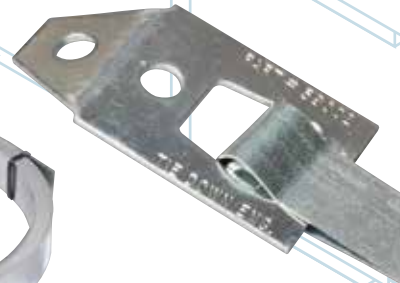
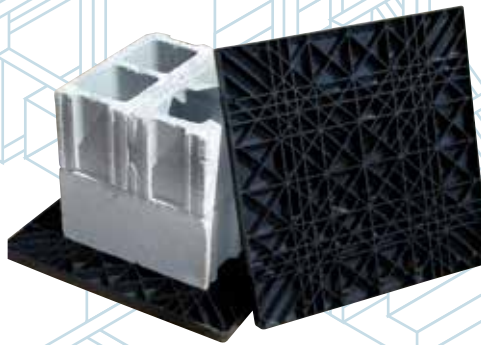
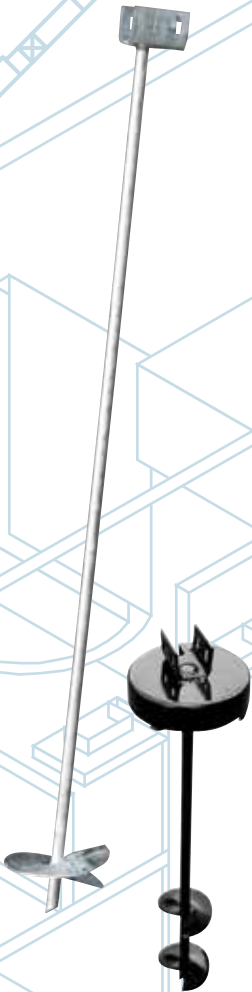

EXPIRATION DATE: 12-31-15

Apr 14, 2015



Apr 14, 2015

Table of Contents

Subject	Description	Page
ABS Pads	ABS Pad Installation	18
ABS Pads	ABS Pad Listings	19
Accessories	Drive Machine	3
Accessories	Outrigger - Adjustable/Diagonal Strut	20
Anchors	Anchor Listings	14
Anchors	Asphalt Anchor	5
Anchors	Concrete "J" Anchor	12
Anchors	Concrete Slab Anchor	12
Anchors	Cross Drive Rock Anchor	13
Anchors	Deep Set Anchor/Stabilizer	4
Anchors	Patio Slab Anchor	12
Anchors	Propane Tank Anchoring Instructions	22
Anchors	Quik Set Stabilizer	5
Anchors	Soil Class & Anchor Chart	16
Anchors	Soil Testing/Anchor Selection	17
Anchors	Stabilizer Plates	4
Anchors	X-Plate Anchor/Stabilizer	13
Connectors	Angle Frame Bracket	11
Connectors	Frame Tie with Hook	9
Connectors	Frame Ties	8
Connectors	Gator Beam Clamps	11
Connectors	Strap Buckle	9
Connectors	Swivel Strap Connectors	10
Connectors	Swivel Strap Universal Connector	10
Piers	Support Piers	21
Strap	Strap - Certified Galvanized Strapping	6
Strap	Strap Attachment	7
Strap	Strap Protectors	8
Strap	Strap Splice	7
Strap	Strap Tensioning	6
Strap	Strap Tensioning - Speed Wrench	7
Transportation	Emergency Hanger Kits	23



TIE DOWN ENGINEERING

255 Villanova Drive SW • Atlanta, Georgia 30336
800-241-1806 • 404-344-0000 • Fax 404-349-0401

ISO 9001:2008 Certification

Trade, brand, names and drawings are the intellectual property of TIE DOWN ENGINEERING.

©2015 TIE DOWN, Inc.

Manual #08235

Frame Tie Anchor Installation

1. Position anchor at a slight back angle (10°) so that when fully installed, the anchor head will be inside any skirting or side wall.
2. Install anchor to +/- 2/3 depth, then install stabilizer vertically, within 3"- 4" of anchor shaft, parallel to wall of home.
3. Fully drive anchor, attach strap (see proper strap tensioning), and pretension strap to pull anchor rod against the stabilizer plate.

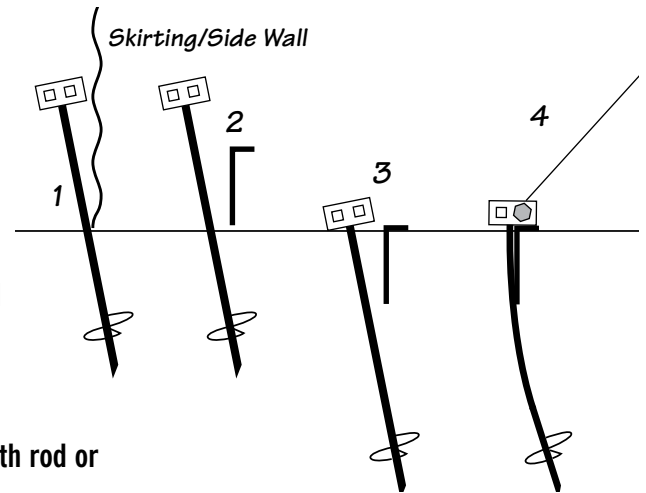

Manual Anchor Installation

1. Dig holes to a depth of 2/3 of the anchor length. Install anchor with rod or length of pipe for leverage.
2. Replace earth in hole after anchor/plate is installed at full depth. Pack dirt with a tamping rod every 6 inches of fill.
3. Testing may be required in loose soil conditions to check that anchor has proper holding power.

IMPORTANT!

Anchor must be installed to full depth. Anchor head must be at ground level or at the top of the stabilizer plate which is fully installed to ground level.

Electric Drive Machine Installation

Operating Instructions:

1. Attach adapter head to shaft of the EDM motor, tighten set screw.
2. Place extension handle in the end of the EDM if needed.
3. Place anchor head into adapter, line up anchor shaft with EDM shaft, for easier installation.
4. Flip forward/reverse switch to forward.
5. Place anchor tip in location where anchor is to be buried. Hold on/off switch to install.



Electric Drive Machine Cautions and Warnings:

- Before installation of any ground anchor, determine that the ground anchors to be installed will not be near any underground electrical cables, phone lines, water lines, sewer pipes, or gas lines. Failure to do so may result in serious injury or death
- The EDM is designed for operation by two people.
- Do not allow the EDM to be wedged against the home or other solid objects, when operating the EDM.
- Electrical cord must be a minimum of 12-2 wire size w/ground up to 50'. Longer cords should be 10-2 wire size with ground.
- Never operate the EDM in wet or rainy conditions.
- Frayed or patched electrical cords should never be used with the EDM.
- Care should be taken to keep electrical cords away from anchors.
- Never operate drive machine without the GFI power cord. Damage to motor and injury to operator can result from by passing the GFI.
- The GFI will shut off power when a ground fault is detected. The GFI will also shut off power when it detects low voltage improper amps required to drive the motor. Many times the problem will be the use of an extension cord that is too long or is too light in gauge.

Anchor Stabilizers

In order to prevent lateral movement of manufactured homes subjected to high wind loads and to comply with HUD's Wind Zone I, II, & III requirements, all lateral frame ties must be attached to a properly stabilized ground anchor. (Two approved methods illustrated below.)

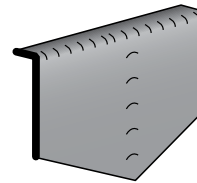

Class 4B Stabilizer Plate
17-1/2" x 13-1/2"
(Part #59286)

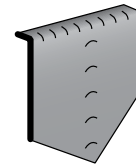

12" wide Stabilizer Plate
(Part #59292 & #59292G)

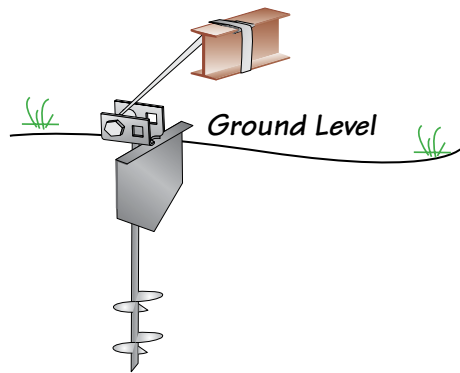
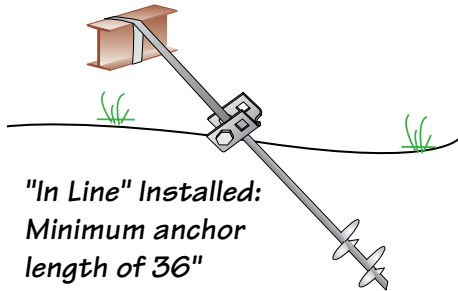

Stabilizer Plate Installation

1. Refer to any and all local, state and federal regulations.
2. Use the Soil Test Probe at the anchor location in order to match soil class with the anchor/stabilizer (see page 16).
3. Partially install anchor to allow 14" to 16" remaining above ground level.
4. Utilizing oversized hammer, vertically install stabilizer plate, nesting anchor rod in between formed channels on outside of stabilizer plate (between anchor and frame).
5. Fully install anchor so that head is at the surface of the soil (1" tolerance, if necessary) and pretension anchor until touching stabilizer plate.

Deep Set Anchor/Stabilizer Instructions

1. Confirm soil classification using standard torque probe at proper depth below ground surface, make certain readings meet or exceed torque readings for Class 2 and 3 soils at the depths of 12" & 36".
2. Clear loose vegetation where anchor will be installed. Install anchor vertically to its' full depth. Stabilizer plate at the top of anchor must be fully embedded into soil.
3. Pull strap past anchor head and cut strap so that there is 12" to 15" of strap to wrap onto anchor bolt insuring 4 to 5 wraps minimum.
4. Insert strap into anchor bolt flush with opposite side of bolt. Tighten bolt/strap until tight. Secure anchor bolt with nut.

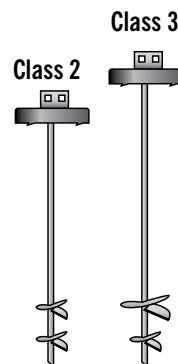

Deep Set Anchor/Stabilizer
30" Black Paint: #59091
30" Galvanized: #59091G
36" Black Paint: #59092
36" Galvanized: #59092G

NOTE:
45° maximum (if angle exceeds 45° attach additional strap tie to opposite frame)

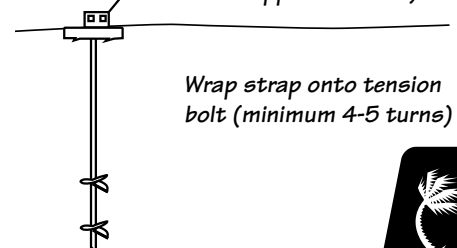

Quik-Set Stabilizer Installation

1. Install ground anchor inside skirting line at a slight back angle of 10° - 15° .
2. While anchor head is still 5" to 6" above ground level: install Quik Set stabilization plate around anchor shaft, referring to the direction imprinted on the top of the plate.
3. Install ground anchor until Quik-Set plate is fully set. Hammering may be required at the corners to insure plate being fully driven.
4. Install strap(s) to anchor head and pretension according to approved methods. Maximum anchor load in conjunction with the "Quik-Set" device is 4725 lbs. (ultimate).

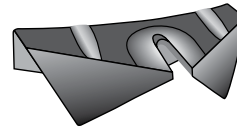

Quik-Set Stabilizer Plate
 Black Paint: #59291
 Galvanized: #59291G

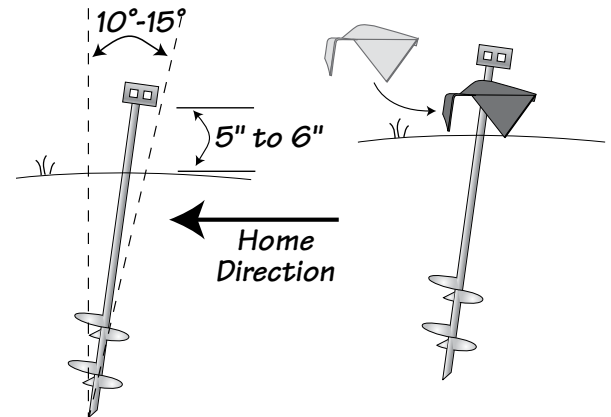

ABS Stabilizer Plate

1. Determine correct anchor to be used with the home installation and use the manufacturer instruction for installation, following all safety precautions.
2. Using an electric drive machine, install anchor to a depth of approximately 28 inches at a slight back angle.
3. Dig out an 8" wide area so that the ABS stabilizer will be placed on undisturbed soil at a 10 to 15 degree angle toward the home. The bottom center of the plate should be touching the anchor rod.
4. Complete the installation of the ground anchor until the bottom of the anchor head is flush with the ground.
5. Attach proper strap and tension strap until anchor head is flush against the ABS plate and strap is tight. At this point, soil should be tamped into the vacant area behind the anchor rod, tamping approximately 6" and repeating until the vacant area is flush with the surface of the surrounding ground.



ABS Stabilizer Plate
 10" x 24"
 Part # 59293

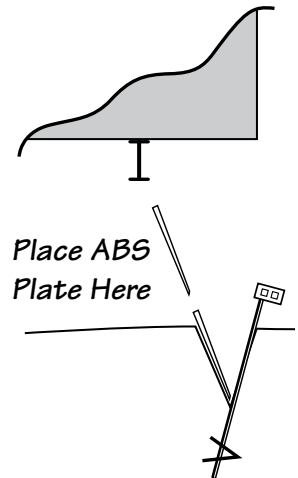

Asphalt Anchor Installation

1. Using a masonry or similar abrasive blade in a circular saw, cut a slot 8" long x 1 1/2" deep in the asphalt where the anchor is to be installed with the plates of the anchor parallel to the structure.
2. With a 5/8" masonry bit installed in a hammer drill, pre-drill a hole approx. 12" deep through the asphalt in the center of the slot.
3. Drive the anchor into the asphalt using a minimum 10 lb. sledge hammer or heavy hammer drill until the upper edge of the top anchor plate is 1" under the asphalt.

For horizontal anchorage at a maximum of 50 degrees, not for vertical anchorage.

Asphalt Anchor
 Part # 59367

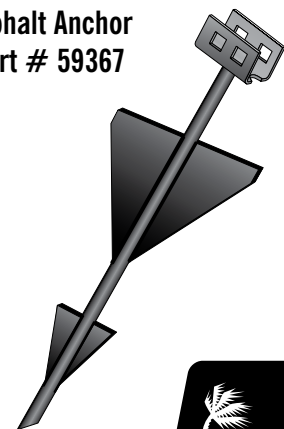

Certified Galvanized Strapping*

The steel strapping by Tie Down Engineering for the manufactured housing industry has been tested to, and conforms to, the HUD Code as referenced in Part 3280 of the Manufactured Home Construction and Safety Standards and Part 3285 of the installation standards; Final Rule.

3280.306(f), 3285.402(b2) Anchoring Equipment – Load Resistance. Anchoring equipment shall be capable of resisting an allowable working load equal to or exceeding 3,150 pounds and shall be capable of withstanding a 50 percent overload (4,725 pounds total) without failure of either the anchoring equipment or the attachment point on the manufactured home.

3280.306(g), 3285.402(b2) Anchoring Equipment – Weatherization

Anchoring equipment exposed to weathering shall have a resistance to weather deterioration at least equivalent to that provided by a coating of zinc on steel of not less than 0.30 ounces per square foot of surface coated, and in accordance with the following:

- (1) Slit or cut edges of zinc-coated steel strapping do not need to be zinc coated.
- (2) Type 1, Finish B, Grade 1 steel strapping, 1-1/4 inches wide and 0.035 inches in thickness, certified by a registered professional engineer or architect as conforming with ASTM Standard Specification D3953-97, Standard Specification for Strapping, Flat Steel, and Seals.

The above specification of a minimum coating of 0.30 ounces per square foot equates to a designation of “G30.” Tie Down strapping exceeds this minimum requirement with a coating of 0.60 (G60) or 1.20 (G120) ounces as per above. Similarly, Tie Down strapping exceeds, in testing, the minimum load requirements of 3,150 pounds design (working) load and 4,725 pounds (ultimate) overload.

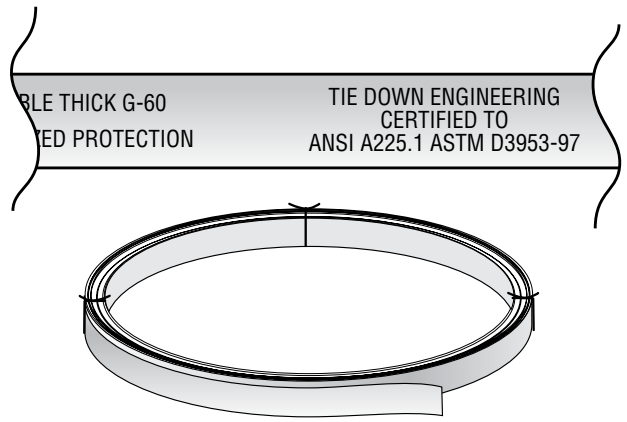

* Available with G60 or G120 galvanized coatings

Proper Strap Tensioning

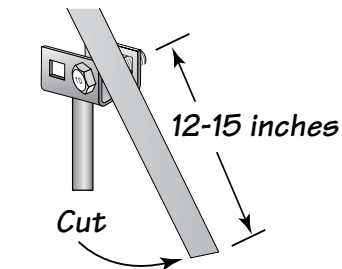

Step 1

Insert slotted bolt into anchor head, attach loosely. Pull strap past bolt head and cut strap so that 12-15 inches of strap are available to wrap onto the slotted bolt.

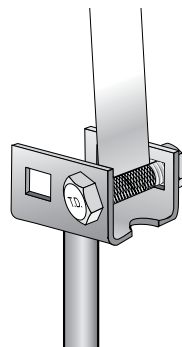

Step 2

Insert the strap end into the slot in bolt until flush with opposite side of bolt.

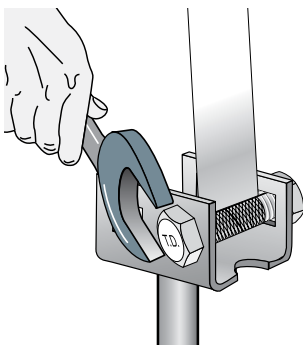

Step 3

Using 15/16" wrench or socket, turn the bolt, winding the strap so that a minimum of four to five complete turns are made, and the strap is adequately tensioned.

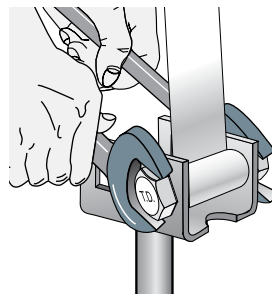

Step 4

Hold the bolt under tension while tightening the nut, drawing the head of the bolt into the recess. After the bolt is within the recess, continue to tighten the nut until securely fastened.

Tip: TIE DOWN'S SPEED WRENCH cuts time required to tension strap in half!

Strap Tensioning - Speed Wrench, Part #48900

Tie Down's SPEED WRENCH simplifies anchor installation with a design that allows for one handed operation for installing slotted bolts and tensioning strap. The SPEED WRENCH has a 15/16" impact socket on one side and a 15/16" "nut" on the other. Combine this with your own ratchet and 15/16" socket and you have the fastest way to tighten slotted bolts!



Step 1

Place Speed Wrench over the bolt head. Insert the strap end into the slot in bolt until flush with opposite side of bolt.



Step 2

Hold Speed Wrench in place, tighten bolt with socket wrench on outside of Speed Wrench (bolt head side).



Step 3

Move socket to the opposite (nut) side. Hold Speed Wrench in place. Use socket wrench to tighten nut.

Strap Splice

To lengthen strap in the field, a double crimp seal splice is required. Overlap strap approximately 12 inches and use two crimp seals evenly spaced, with 2 crimps per seal.



2 Seals - 2 Crimps Per Seal

Strap Attachment

One crimp seal is used when strap is attached to a sidewall bracket or a strap connector. If the bracket does not have a radius edge, a radius clip (short "U" shaped piece of strap) must be placed between the strap and contact point to protect the strap from sharp edges. Verify state requirements for number of crimp seals required.

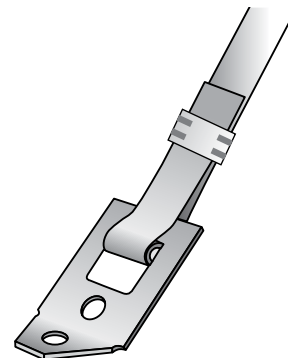

Strap Protectors

For protecting Vertical and Diagonal Strapping at sharp corners when wrapping the top and bottom of the beam.

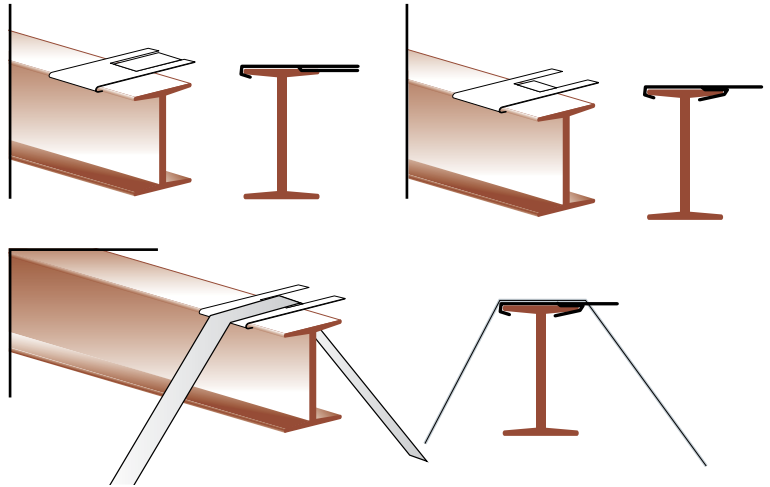

Attach hook between strap and I-beam and fold perforated lip around the beam leaving 2 legs to guide the strap into position.

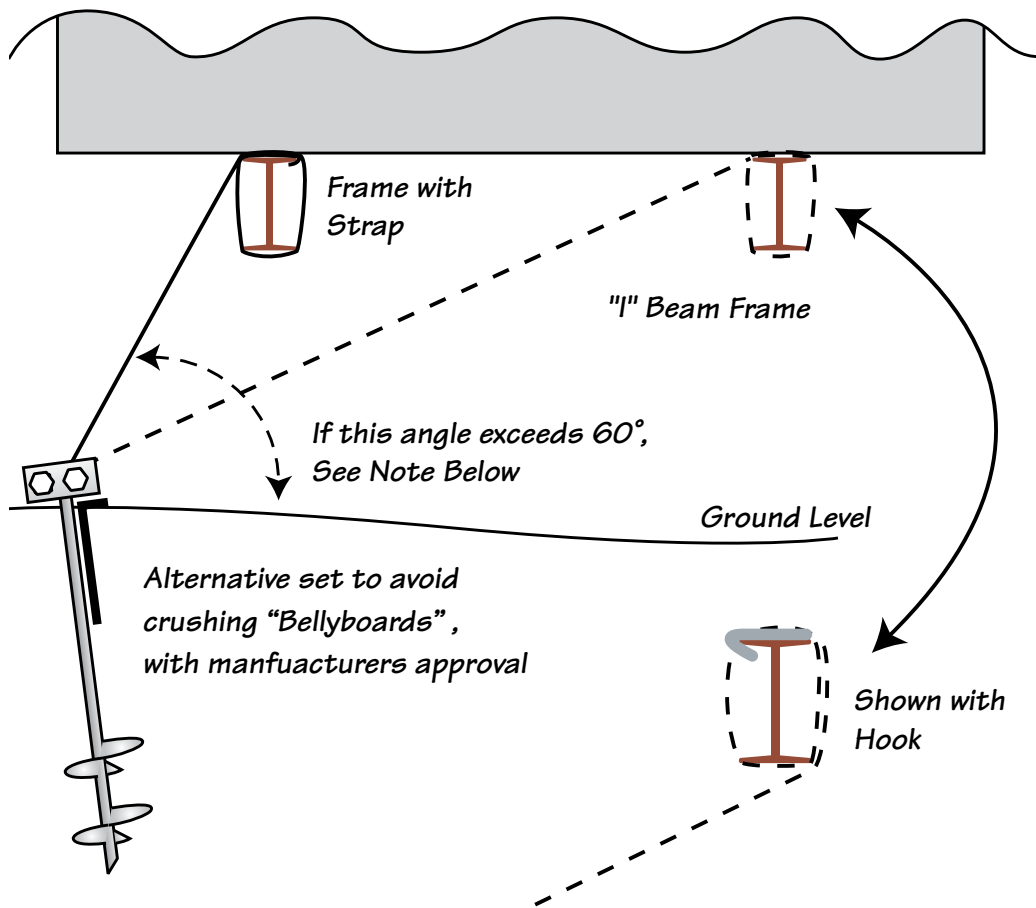

Frame Tie to Anchor

If this angle exceeds 60°, an additional frame tie must be attached to the opposite beam as indicated by the dotted line.

A Stabilizer Plate must be installed on all frame Ties. (or alternate method of stabilizing ground anchor.)

Select proper anchor for soil conditions using the Soil Test Probe, or other approved method of determining soil classification.

NOTE: Make sure you have strap protection against sharp edges for the applications on this page.

Frame Tie with Hook

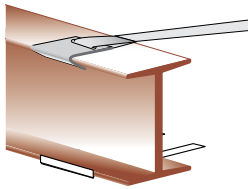

Step 1
Attach frame hook to top inboard location of "I" beam.

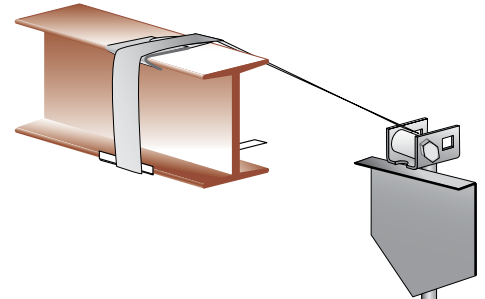

Step 2
Keeping in line with the hook, wrap galvanized strap completely around "I" beam.

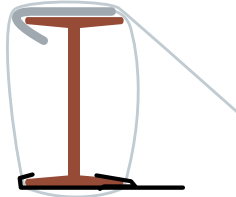

Step 3
Thread loose end of strap through slotted tensioning bolt attached to tension head of anchor. (Anchor must be properly installed into the ground before proceeding with step #4.)

Step 4
Tighten slotted tensioning bolt a minimum of 4 to 5 full turns until all slack in strap is removed.

Frame Tie with Buckle

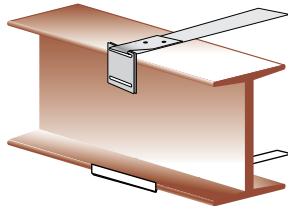

Step 1
Install strap by pushing the end between the inside of the frame "I" beam and the floor.

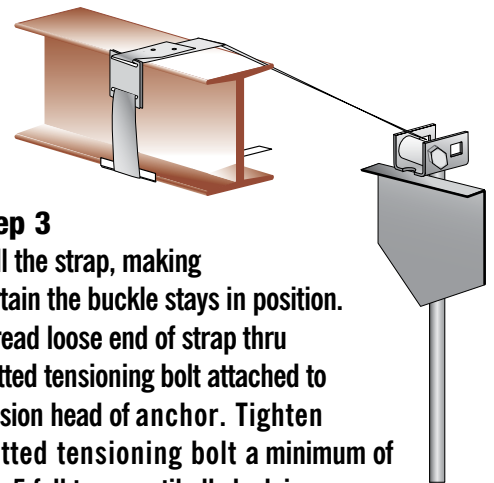

Step 3
Pull the strap, making certain the buckle stays in position. Thread loose end of strap thru slotted tensioning bolt attached to tension head of anchor. Tighten slotted tensioning bolt a minimum of 4 to 5 full turns until all slack in strap is removed.

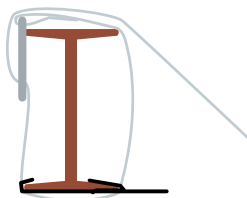

Step 2
Position the buckle at upper end of the "I" beam frame. Wrap the end of the strap around the "I" beam. Thread the end of the strap through the slot in the buckle as shown. Push the end of strap in-between "I" beam and floor.

Strap Buckle - MBU

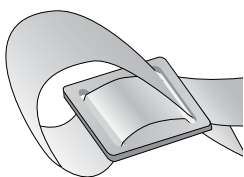

Step 1
Thread length of frame tie strap through strap buckle as shown.

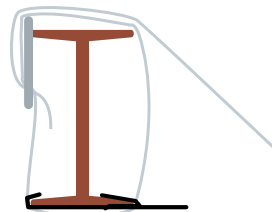

Step 3
Diagram shows strap in position around frame and through buckle. It is important to remove all slack from system.

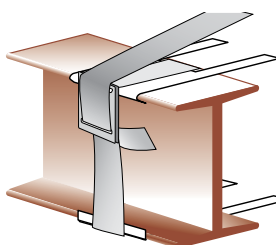

Step 2
Next, thread long end of strap between frame and floor of home. Bring strap through buckle as shown in diagram and fasten to anchor head.

NOTE - Swivel Strap Connectors

1. Refer to local, State, and Federal regulations prior to installation in order to assure compliance.
2. Soil Test Probe the anchor location prior to installation in order to match the soil classification with the proper anchor/stabilizer combination.
3. Install tested and approved Tie Down Engineering anchor products.
59002 & 59242 Swivel Strap Connectors.

**Swivel Strap Connectors
Beam Method:**

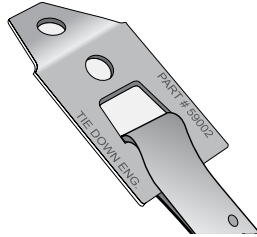

Step 1
Frame ties attach to the beam with a swivel frame connector. This method provides the strongest and safest connection.

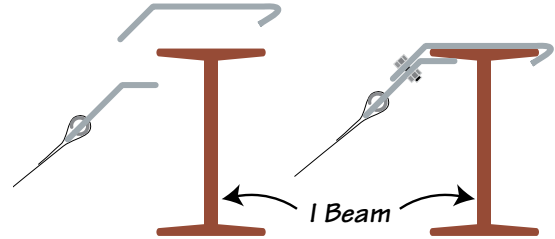

Step 2
Attach the swivel frame connector beam hook to the top of the I-beam from either the front or the back side. The angled or hook end of the beam hook should be snug against the inside top I-beam flange.

Step 3
Attach the swivel connector to the underside of the flange and frame hook with a 1/2" grade 5 bolt and nut. This allows the swivel connector to pivot and lock onto the I-beam.

**Universal Swivel Strap Connectors
Sidewall Methods:**

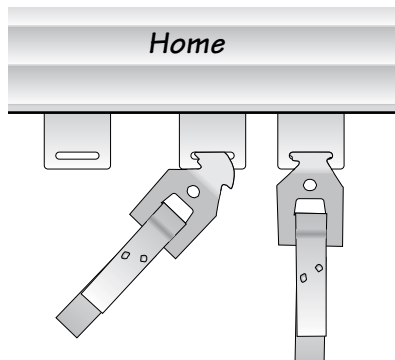

Sidewall & Longitudinal Slotted
Insert strap connector at a 45 degree angle. Return to 90 degree angle, pull down and attach to ground anchor. (Slotted connections must be straight pull. Bolted connections can have 15 degree max. angle.)

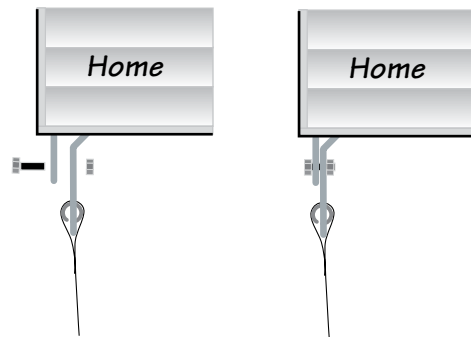

Sidewall w/Nut & Bolt
Attach strap connector to sidewall connector with nut & bolt, then attach to ground anchor.

Gator Beam Clamp

4 Bolt Gator Clamp (Wind Zone 1, 2 & 3) #58999

8 Bolt Gator Clamp (Wind Zone 3 - and Florida) #59011

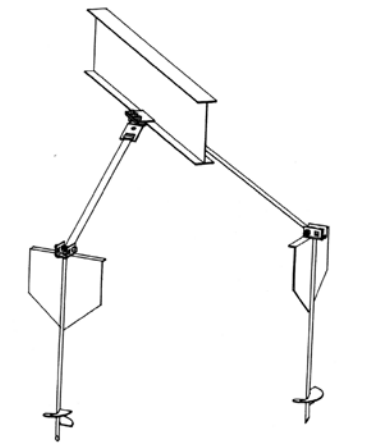
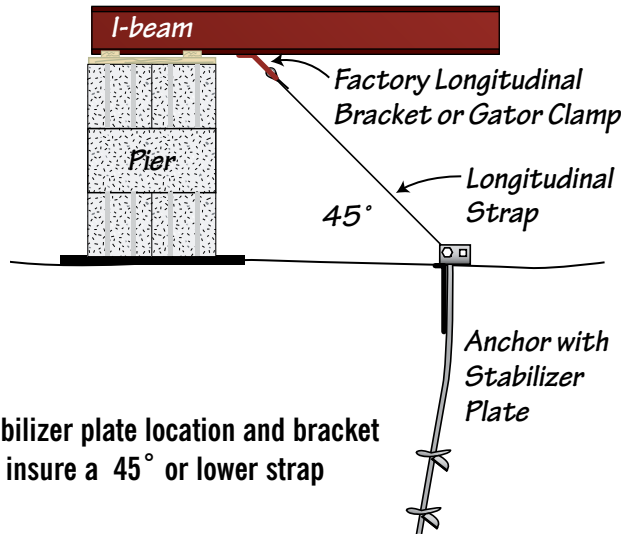

1 Strap for Wind Zone I
2 Straps for Wind Zones II & III

Step 1

Determine anchor/stabilizer plate location and bracket location on I-beam to insure a 45° or lower strap angle.

Step 2

Attach beam clamp with 1/2" Grade 5 bolts and nuts as shown.

Step 3

Connect swivel connector and strap to bolt nearest to anchor with a 1/2" Grade 5 bolt and nut.

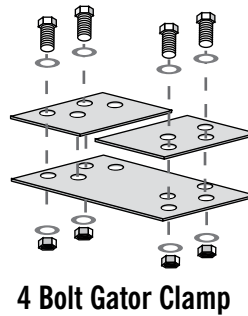

4 Bolt Gator Clamp

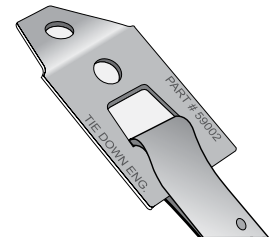

NOTE:

Gator Beam Clamps must be attached with a Swivel Strap Connector #59002.

Angle Frame Bracket Part #59009

NOTE:

Frame Brackets must be attached with a Swivel Strap Connector #59002.

Step 1

Determine anchor/stabilizer plate location and bracket location on I-beam to insure a 45° or lower strap angle .

Step 2

Drill a 1/2" hole, centered in the I-beam as shown. Hole must be a minimum of 4" from any edge of the I-beam.

Step 3

Connect the two Frame Brackets (R & L) with a 1/2" Grade 5 bolt and nut for Wind Zone II & III and one frame bracket right or left for Wind Zone I.

Step 4

Attach swivel connector and strap to Angle Frame Brackets with 1/2" Grade 5 bolts and nuts. Tighten all bolts.

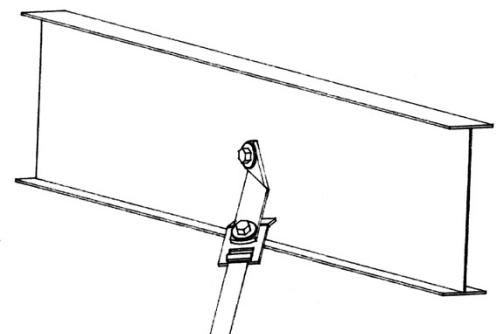

Note Applies to all anchors on this page:

- Maximum load per anchor is 4725 lbs.
- Minimum slab area per anchor for 4725 lbs.:

4" Thick Slab: 95 S. F.	6" Thick Slab: 65 S. F.	8" Thick Slab: 48 S. F.
-------------------------	-------------------------	-------------------------
- When installed in slabs with a thickness of 4" or less, a layer of 6/6 or 10/10 mesh is recommended.

Patio Slab Anchor

This anchor is designed to be inserted through a 3/4" hole drilled or formed into an existing concrete slab.

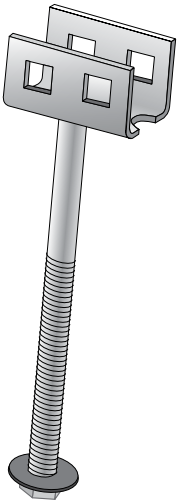

- Concrete must be a 2500 PSI minimum slab with 4" minimum thickness.
- Concrete slab must allow 4725 lbs of vertical tension on anchor without lifting. This assumes that the concrete weighs 150 lbs per cu. ft.
- Minimum distance from the anchor shaft to one edge of the slab is 4 in. from one edge and 2 ft. from any other edge.

Concrete "J" Anchor

The MIJ2 is designed to be installed into a concrete slab at the time the concrete is being poured.

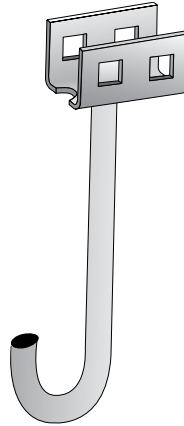

- Concrete must be a 2500 PSI minimum slab with 4" minimum thickness.
- Concrete slab must allow 4725 lbs of vertical tension on anchor without lifting. This assumes that the concrete weighs 150 lbs per cu. ft.
- Minimum distance from the anchor shaft to one edge of the slab is 4" from one edge.
- Concrete slab must have a minimum thickness equal to the anchors length plus 2" at embedment locations.



Concrete Slab Anchor

This anchor is designed to be bolted to an expansion sleeve in an existing concrete slab.

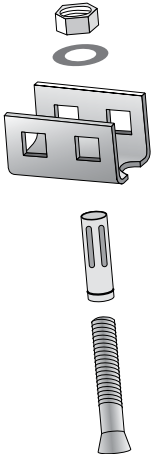

- Drill a 5/8 in x 3 in. hole in the slab where the anchor head is to be located.
- Place steel expansion sleeve over bolt and place into the drilled hole.
- Place the washer onto the expansion bolt.
- Thread nut onto expansion bolt and tighten until maximum expansion of steel expansion sleeve has been achieved.
- Remove nut and washer and place anchor head over exposed bolt.
- Place washer and nut onto bolt to attach anchor head, tighten nut.
- Concrete must be a 2500 PSI minimum slab with 4" minimum thickness.
- Concrete slab must allow 4725 lbs of vertical tension on anchor without lifting. This assumes that the concrete weighs 150 lbs per cu. ft.
- Minimum distance from the anchor shaft to one edge of the slab is 4 in. from one edge and 6" from any other edge.



Cross Drive Rock Anchor - MRA

Engineered for installation into solid rock within 1 in. from bottom of the anchor base. Exact alignment is achieved with the swivel tensioning head.

1. Drill 5/8" diameter hole 5-1/2" deep in center of anchor location. Insert pilot stud into hole.
 2. Drill two 3/4" diameter holes, (the length of the rods) into the rock at 45° angles, using the anchor head as a locating guide.
 3. Place rod through top and corresponding bottom web flange and into 45° hole. Drive rod into rock. Rod must be driven into rock at least 80% of it's length to achieve minimum allowable pullout resistance. Repeat using 2nd rod.
- Maximum pullout resistance is developed when ground surface is solid rock. Maximum distance from lowest edge of anchor flange to rock surface is 1 in.

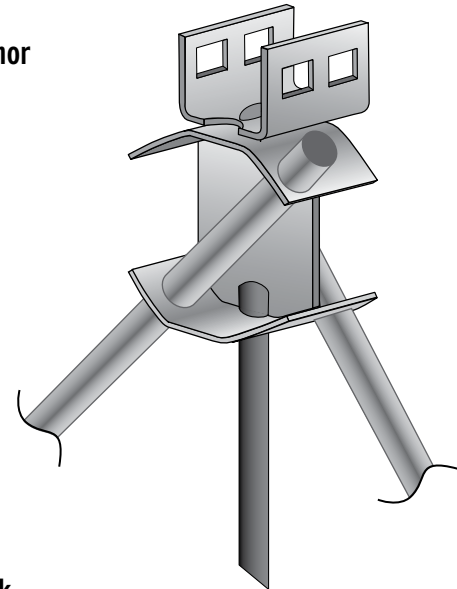

30" Part #59110
48" Part #59111

X-Plate Anchor with Stabilization Plate

Painted Part #59118

Galvanized Part #59118G

X-Plate for Soil Class 2

2 - 23/32" x 30" rods included.

Engineered for installation into difficult ground conditions that, when tested with a soil test probe, exceed 500 in. lbs. (see notes below).

Using a soil test probe, determine the soil classification. Place the X-Plate parallel to the building being secured with the flat plate to the inside. Pound the plate into the ground so that the upper lip is ground level. Using a heavy hammer or electric hammer gun, pound rods into the ground through the box tubing guides welded onto the back side of the stabilizer plate. Rods should be installed until maximum 2" above the box tubing. Install strap as required.

Notes:

1. For Wind Zone 1 use only, max working load of the X-Plate is 2,200 lb. (3,300# ultimate).
2. It takes 1-1/2 X-Plate anchors to replace 1 standard class 2 ground anchor with a 3150 lb. working load.
3. Difficult Soils Only - Defined as "Extremely hard soil preventing the installation of an auger anchor to its full depth using a 1/2 HP Drive Machine". Torque probe readings at 12" to 18" of the surface must be 500 "/# min.
4. Cross drive anchor is NOT rated or intended to be used for direct pull in vertical direction. Angle of resultant load must be at 40-50 degrees from vertical. This anchor may not be appropriate for shear wall or column anchorage.

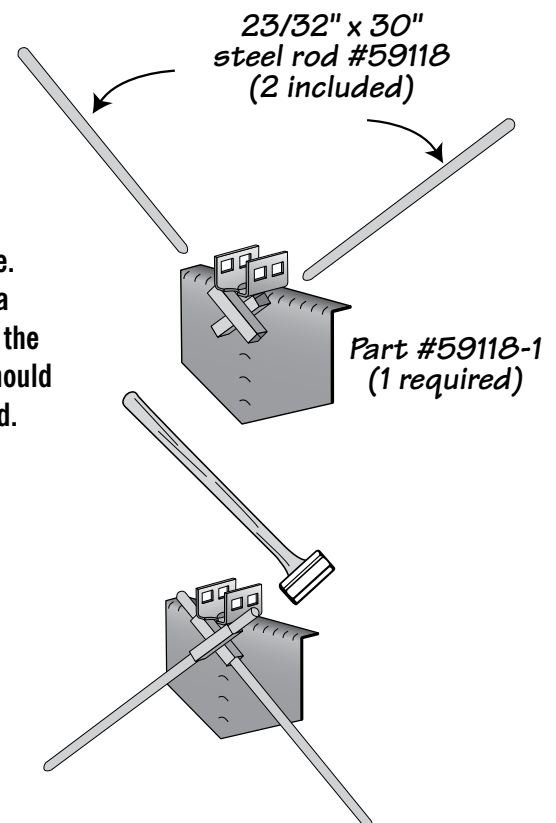



RESOURCES,
APPLICATIONS,
DESIGNS, &
CONTROLS, INC.
3220 E. 59th Street
Long Beach, CA 90805

LISTING #1349

Tel: (562) 272-7231

Fax: (562) 529-7513

LISTING & TESTING DIVISION

PRODUCT: CONCRETE, ROCK, AND SOIL GROUND ANCHORS

MANUFACTURER: Tie Down Engineering
255 Villanova Dr. SW
Atlanta, GA 30336

Issued: December 2013

Subject to renewal in December 2014

PLANT LOCATION: 255 Villanova Dr. SW
Atlanta, GA 30336

APPLICATION: HUD Code Manufactured Homes & Modular Homes

1. INTRODUCTION

At the request of Tie Down Engineering, RADCO investigated the possibility of listing ground anchors produced by Tie Down Engineering, for approval of ground anchors in accordance with RADCO's Listing Requirements for Ground Anchors.

RADCO's Listing Requirements for Ground Anchors defines the classification and performance requirements of each respective ground anchor model. The requirements are in general accordance with those developed by the MHI Ground Anchor Task Force and adopted by HUD's MHCC on March 9, 2011 after accepting minor revisions offered by HUD staff.

2. DESCRIPTION

There are three categories of ground anchors that are specified in this listing. The first group is soil ground anchors, which pertain to all anchors designated for soil classes 2, 3, 4, and 5. The second group is concrete (non-soil) ground anchors, which are designed for installation into class 1 conditions. The third group is a set of soil ground anchors which serve as an alternate to the HUD minimum requirements and are listed with a working load which is less than the requirements prescribed by the MHI Ground Anchor Task Force and adopted by HUD's MHCC on March 9, 2011.

All Tie Down Engineering Ground Anchors are manufactured using steel in conformance with ASTM A-36. The models under this listing vary with respect to shaft diameter, number and location of helixes, length of shaft and stabilizer device. Table 1 shows a complete description of each ground anchor model, as well as a corresponding stabilizer device.

All ground anchors have a minimum working load of 3,150 lbs and a minimum ultimate load of 4,725 lbs, with the exception of the anchors listed in Table 3.

3. INSTALLATION

The Installation of the ground anchors is to be in accordance with the Manufacturer's Installation Instructions, as well as:

- a) The proper soil class. (Tables 1 & 3, and notes)
- b) Minimum angle of pull to the horizontal. (Tables 1 - 3)

4. EVIDENCE SUBMITTED

- 4.1 Testing has been conducted to verify the compliance of Tie Down Engineering ground anchors to the RADCO Listing Requirements for Ground Anchors.

- 4.2 The quality and process control system used in the manufacture has been submitted to RADCO. An adequate method of traceability is maintained by the manufacturer. A follow-up quality assurance audit program is maintained by RADCO.

5. RECOMMENDATIONS

RADCO recommends that Tie Down Engineering ground anchors be accepted for use with HUD code manufactured homes and modular homes provided that:

- 5.1 Each ground anchor will be marked with a label, a facsimile of which is shown in figure 1. The label for each facility denotes the RADCO name, and Listing #1349.
- 5.2 All products are produced only at the facility referenced in this listing.
- 5.3 The quality control procedures are maintained by the manufacturing facility as submitted.
- 5.4 The audit system of RADCO is maintained.
- 5.5 All products are installed per the manufacturers installation instructions and section 3 of this listing.

6. APPROVAL

This listing is subject to approval on an annual basis by RADCO. Updating and further information will be included and/or resubmitted as necessary.

Figure 1: Sample Label



Table 1: Properties of HUD Approved Ground Anchors

Model	Shaft Diameter (in)	Shaft Length (in)	Helix	Working Load (lbs)	Min. Ultimate Load Capacity (lbs)	Min. Stabilizer Device (See Note 2)	Min. Soil Class (See Note 1)	Min. Angle of Pull to Horizontal
M1C2	0.625	30	2 Barbs	3655	5483	None	2	vertical only
MRA	0.718	30	Cross Drive	3611	5417	None	1	vertical only
59091	0.719	29.5	2 @ 4"	3150	4725	7" Dia Cap	3	45
59092	0.719	34	1 @ 6", 1 @ 4"	3150	4725	7" Dia Cap	4	45
59097	0.75	60	2 @ 4"	3267	4900	None	2	45
59128	0.75	42	2 @ 4"	3200	4800	No 59292	4a	45
59086	0.75	47	2 @ 4"	3200	4800	No 59292	3	45
M12H64	0.719	34	1 @ 6", 1 @ 4"	3467	5200	No 59292	4	45
M12H 3/4	0.742	48	1 @ 6"	3645	5467	No 59292	4	45
MI2H	0.625	48	1 @ 6"	4045	6067	MLATSTA	4	45
MI2H6	0.625	36	1 @ 6"	3700	5550	MLATSTA	3	45
MI22	0.75	30	2 @ 4"	3567	5350	MLATSTA	2	45
M607	0.75	60	1 @ 7"	3922	5883	No 59285	4b	45
59085	0.75	48	1 @ 6"	3467	5200	No 59286	4b	45

Table 2: Properties of HUD Approved Concrete Anchors

Model / Part No.	Working Load (lbs)	Min. Ultimate Load Capacity (lbs)	Min. Angle of Pull (horiz.)
59109	3333	5000	45
59120	3333	5000	45
ICS1	3200	4800	45
ICS2	3167	4750	45
MIJ2	3333	5000	45
MIT2	4000	6000	45

Table 3: Properties of Alternate (Non-HUD Approved) Ground Anchors

Model	Shaft Diameter (in)	Shaft Length (in)	Helix	Working Load (lbs)	Min. Ultimate Load Capacity (lbs)	Min. Stabilizer Device (See Note 2)	Min. Soil Class (See Note 1)	Min. Angle of Pull to Horizontal
59113	0.72	30	none	2200	3300	No. 59118-1	3	45
59080	0.625	48	1 @ 6"	3722	5583	No. 59292	4	45
59050	0.5	15	1 @ 4"	533	800	None	2	Vertical
59055	0.5	30	1 @ 4"	1600	2400	None	2	Vertical
59060	0.625	40	1 @ 6"	3000	4500	None	3	Vertical
59065	0.625	48	1 @ 6"	2000	3000	None	4	Vertical
59040	0.75	60	1 @ 8"	2267	3400	None	4	Vertical

Note 1: See 24 CFR Part 3285 Model Manufactured Home Installation Standards, section 202: Soil Classification and Bearing Capacity & Table 3285.202 for an explanation of soil classification numbers. Please note that anchors approved for use in soil class 4 may be used in soil classes 3 or 2, and anchors approved for use in soil class 3 may be used in soil class 2.

Note 2: Please see the appendix of the Tie Down Quality Control manual for specifications of each stabilizer plate.

Soil Classification Chart

Ground anchors are designed for different soil classifications: longer models for loose soils, shorter models for harder soils. Prior to installing any ground anchor model, the soil must be tested (with a Soil Test Probe) in order to match approved ground anchor model with site soil class.

WARNING: Before ground anchor installation, determine that the anchor locations around home will not be close to any underground electrical cables, water lines or sewer piping. Failure to determine the location of electrical cables may result in serious personal injury.

Soil Test Probe

The Soil Test Probe is used to determine the soil conditions below the surface near the anchor's helix. Using the Soil Test Probe will ensure maximum anchor holding strength by indicating the proper anchor model for each soil condition.

Using the chart provided, a probe reading can be converted to the recommended anchor for every soil condition.

Instructions

1. Place probe tip into ground where you intend to place the anchor. Using a 15/16" hex socket with a ratchet or breaker bar, rotate the probe in a clockwise direction. (An electric drive machine with an adaptor head may also be used)
2. Drive (rotate) the torque probe into the soil until reaching a depth equal to the length of the anchor being installed.
3. To determine the soil classification:
 - Place wrench adaptor onto torque wrench.
 - Insert hex portion of wrench adaptor onto the earth probe.
 - Support probe shaft with one hand, while rotating probe steadily with the wrench. (Do not exceed 600 in. lbs.)
 - Read the torque wrench while rotating probe clockwise.
 - Use the soil classification chart to cross reference probe readings. Color codes match those printed on Tie Down's torque probe.
4. If probe reading does not match the anchor for that depth, rotate probe to next anchor depth and check reading. Continue until reading on probe matches anchor length for depth of reading.
5. To remove probe, use wrench or electric drive machine in reverse (counter clockwise).

Soil Class	Test Value (in. lbs.)	Soil Description
1	N/A	Sound hard rock.
2	550 +	Very dense and/or cemented sands, coarse gravel, cobbles, preloaded silts, clays and coral.
3	351 to 550	Medium dense coarse sands sandy gravels very stiff silts and clays.
4a	276 to 350	Loose to medium dense sands, firm to stiff clays and silts, alluvial fill.
4b	175* to 275	Loose sands, firm clays and silts, alluvial fill.

* Below 175 in. lbs., a professional engineer should be consulted

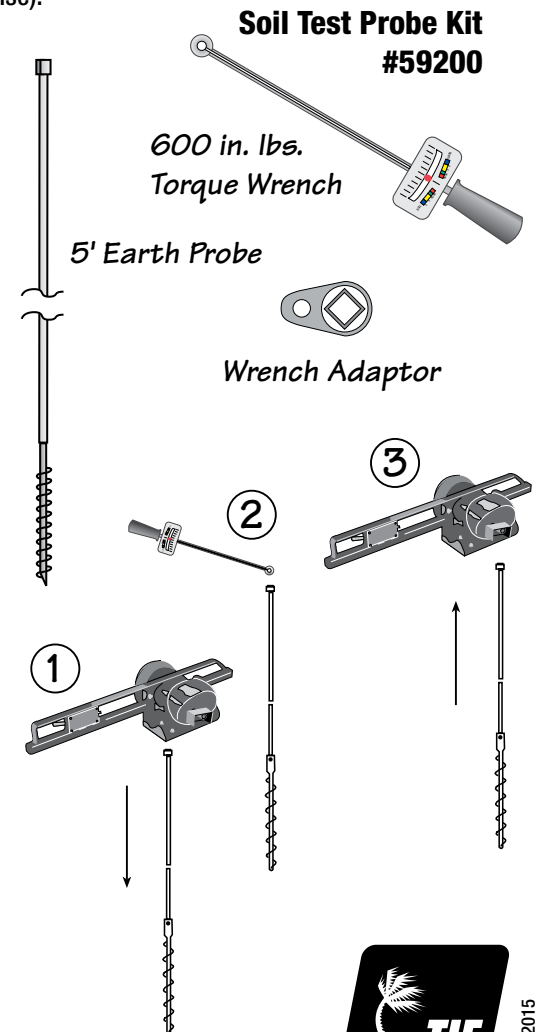

NOTE: Each State, County or Municipality may require a specific anchor from the groups shown for each soil classification. Check local and State regulations first.

Anchor Chart

Soil Class & Test Values (in. lbs.)		Recommended Anchor / Stabilizers	Part Number Black	Part Number Galvanized	
1	N/A	30" Cross Drive Rock Anchor	59110	59110G	
		48" Cross Drive Rock Anchor	59111	59111G	
2 Blue	550 lbs +	30" X 5/8" rod / 2 - 4" helix	59090	59078	
		30" X 3/4" rod / 2 - 4" helix	59095	59079	
		60" X 3/4" rod / 2 - 4" helix	59097	59097G	
		All anchors above should use one of the following when subjected to lateral loads:			
		12" Stabilizer Plate	59292	59292G	
		Quik-Set Stabilization Plate	59291	59291G	
-----		X-Plate Anchor with 2-23/32" Rods	59118	59119	
3 Yellow	351 to 550 lbs.	48" X 5/8" rod / 1 - 6" helix	59080	59081	
		48" X 3/4" rod / 1 - 6" helix	59085	59094	
		36" X 3/4" rod / 1 - 6" helix & 1 - 4" helix	59250	59250G	
		All anchors above should use one of the following when subjected to lateral loads:			
		12" Stabilizer Plate	59292	59292G	
		Quik-Set Stabilization Plate	59291	59291G	
-----		Deepset Anchor 30" X 3/4" rod / 2 - 4" helix	59091	59091G	
4a Green	276 to 350 lbs.	48" X 5/8" rod / 1 - 6" helix	59080	59081	
		48" X 3/4" rod / 1 - 6" helix	59085	59094	
		36" X 3/4" rod / 1 - 6" helix & 1 - 4" helix	59250	59250G	
		3/4" rod, 42" long, 2- 4" helix, Class 4A	59128	59128G	
		3/4" rod, 48" long, 2-4" helix, Class 4A	59086	59086G	
		All anchors above should use one of the following when subjected to lateral loads:			
12" Stabilizer Plate	59292	59292G			
17 -1/2" Stabilizer Plate (Florida Only)	NA	59286			
Quik-Set Stabilization Plate	59291	59291G			
ABS Stabilization Plate (Florida Only)	59293	NA			
-----		Deepset Anchor 36" X 3/4" rod / 4" & 6" helix	59092	59092G	
4b Red	175 to 275 lbs.	60" X 3/4" rod / 1 - 7" helix	NA	59099	
		All anchors above should use one of the following when subjected to lateral loads:			
		17 -1/2" Stabilizer Plate	NA	59286	
		ABS Stabilization Plate	59293	NA	

NOTE: Each State, County or Municipality may require a specific anchor from the groups shown for each soil classification. Check local and State regulations first.



Installation Instructions for ABS Pads

1. Pier spacing must be in accordance with the Manufacturers Installation Manual and/or State or local requirements.
2. Clear all vegetation and debris from area where pads are to be placed.
3. The ground under the pads must be leveled and evenly compacted or undisturbed soil.
4. Determine pad size by testing for the soil bearing capacity, if soil testing not available, use the 1000 PSF soil column of the instructions.
5. Place ABS pad with grid side up, smooth side down. Center blocks or pier on pad and complete Installation.

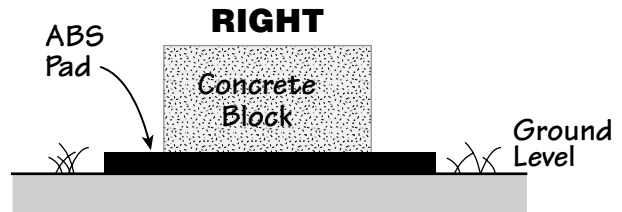
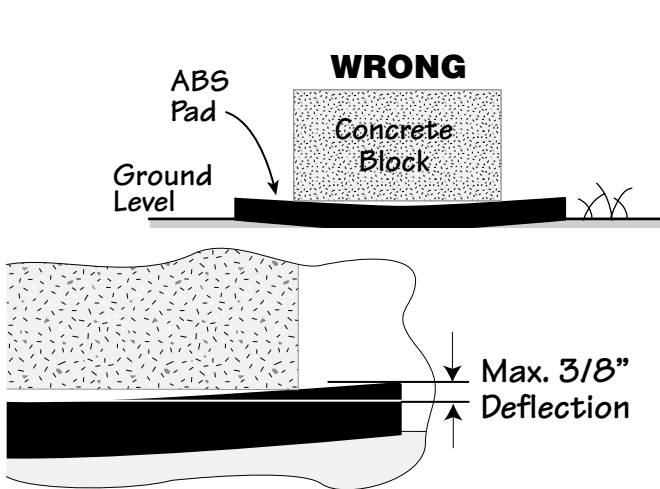

IMPORTANT

If pad deflects more than 3/8" when installed correctly with home's dead load applied, then the pier spacing is incorrect for soil conditions

General Notes:

1. Any configuration from the chart may be used to replace a concrete or wood base pad per 3282.312(A)(3).
2. The maximum load at any intermediate soil value may be interpolated between the next lower and next higher soil values given in the pad bearing capacity chart.
3. Pad sizes are shown in nominal dimensions and may vary slightly.
4. Maximum deflection 3/8", measured from the highest point to the lowest point of the top side of pad.
5. In areas susceptible to frost heave, the pad must be at the frost line or otherwise protected from the effects of frost. Refer to NCSBCS/ANSI A225.1 "Manufactured Home Installations" Homes set to Standard 24 CFR 3285 should not be susceptible to frost heave.

Pad Bearing Capacity					
ABS Pad Size	Part#	1000 lbs. Soil	2000 lbs. Soil	3000 lbs. Soil	
16" x 18" - 2 Sq. Ft. 288 Sq. In.	59300	2,000 lbs.	4,000 lbs.	6,000 lbs.	
16" x 22.5" - 2.5 Sq. Ft. 360 Sq. In.	59301	2,500 lbs.	5,000 lbs.	7,500 lbs.	
17" x 25" - 3 Sq. Ft. 432 Sq. In.	59302	3,000 lbs.	6,000 lbs.	N/A	
24" x 24" - 4 Sq. Ft. 576 Sq. In.	59303	4,000 lbs.	8,000 lbs.	N/A	
Multi Pad Layout					
32" X 22.5" (See 1 below) 5 Sq. Ft. - 720 Sq. In.	3 X 59301	5,000 Lbs.	10,000 Lbs.*		
34.4 X 25.2 (See 2 below) 6 Sq. Ft. - 864 Sq. In.	3 X 59302	6,000 Lbs.	12,000 Lbs.*		

* Concrete Block rated @ 8000 lbs. Double block any higher loads.

1. The 32 X 22.5 Pyramid configuration uses 2 - 16 X 22.5 pads placed side by side with 1 - 16 X 22.5 pad on top in the opposite direction.
2. The 34.4 X 25.4 Pyramid configuration uses 2 - 17.2 X 25.2 placed side by side with 1 - 17.2 X 25.2 Pad on top in the opposite direction.

Single Stack Course

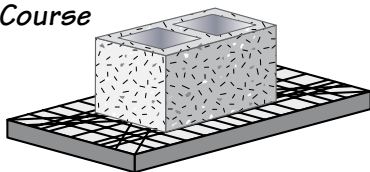

Double Stack Course

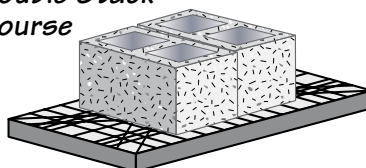

Multi Pad Layout

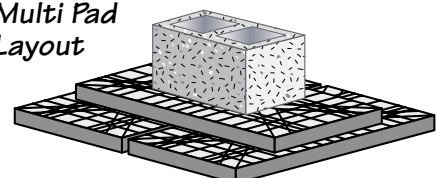



**RESOURCES,
APPLICATIONS,
DESIGNS, &
CONTROLS, INC.**
3220 E. 59th Street
Long Beach, CA 90805
Tel: (562) 272-7231
Fax: (562) 529-7513

DESIGN LISTING # 1345

LISTING & TESTING DIVISION

PRODUCT: ABS FOUNDATION PADS

Issued: October 2012

LISTEE: TIEDOWN ENGINEERING, INC.
5901 Wheaton Drive
Atlanta, GA 30336

CATEGORY: DESIGN - FOUNDATION

APPLICATION: MANUFACTURED HOME - FOUNDATION

SECTION 1: INTRODUCTION

At the request of Tiedown Engineering, Inc., **RADCO** has examined their ABS Foundation Pads to determine the design load capacity in accordance with Section 3280.401(b) of The Federal Manufactured Home Construction and Safety Standards.

SECTION 2: DESCRIPTION

The ABS pads are molded ABS pads having continuous ribs running parallel and diagonal with the pad sides. The ABS pads may be used to distribute concentrated pier loads to underlying soil for manufactured housing constructed in accordance with The Federal Manufactured Home Construction and Safety Standards 24 CFR Part 3280. The ABS pads are available in various sizes as noted in Table 1.

SECTION 3: APPLICATION

The ABS pads shall be installed in accordance with the manufacturer's installation instructions. The maximum design concentrated loads are provided in Table 1.

SECTION 4: EVIDENCE SUBMITTED

- a) Test report of "Full Scale ABS Footer Test: by K2 Engineering, Inc. Test Report #99-MH01-TDE, January 1999.
- b) Test report of "Full Scale ABS Footer Test: by K2 Engineering, Inc. Test Report #99-MH05-TDE, May 1999.
- c) Test report of "Full Scale ABS Footer Test: by K2 Engineering, Inc. Test Report #99-MH06-TDE, May 1999.
- d) Test report of "Full Scale ABS Footer Test: by K2 Engineering, Inc. Test Report #99-MH07-TDE, May, 1999.
- e) Test report of "Full Scale ABS Footer Test: by K2 Engineering, Inc. Test Report #99-MH09-TDE, September, 1999.
- f) Test report of "Full Scale ABS Footer Test: by K2 Engineering, Inc. Test Report #00-MH15-TDE, September, 2000.
- g) Test report of "Full Scale ABS Footer Test: by K2 Engineering, Inc. Test Report #01-MH17-TDE, August 2001.

SECTION 5: RECOMMENDATIONS

RADCO recommends that the ABS pads be accepted for use of ABS pads in bearing capacity of soils listed in Table 1 for support of concrete masonry unit piers, provided that:

- a) The home installation follows all Manufacturers Installation Design Instructions for the ABS pads.
- b) Each ABS pads shall be marked with manufacturer name and address, product name, RADCO name/logo and Listing #1345.
- b) The ABS pads are of the same quality and size as tested by K2 Engineering, Inc.
- c) Pies are limited to single or double stacked concrete masonry unit blocks.
- d) The design pier load does not exceed the lesser of the pad capacity, soil capacity or pier capacity.
- c) The home installer is responsible for the foundation design of each home.

SECTION 6: APPROVAL

This listing is subject to approval on an annual basis by **RADCO**. Updating of data and further information will be submitted as necessary.

Table 1: Maximum Design Load Capacity for ABS Pads

Model	ABS Pad Size	Soil Bearing Capacity		
		1,000 psf	2,000 psf	3,000 psf
59300	16"x18"	2,000	4,000	6,000
59301	16"x22.5"	2,500	5,000	7,500
59302	17"x25"	3,000	6,000	N/A
59303	24"x24"	4,000	8,000	N/A



Adjustable Outrigger/Diagonal Strut Installation

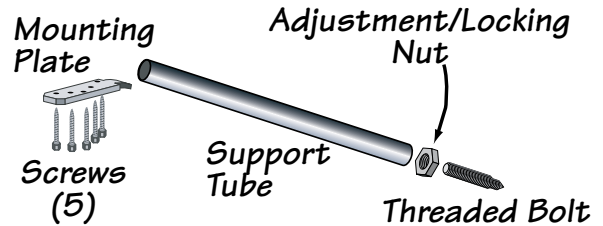
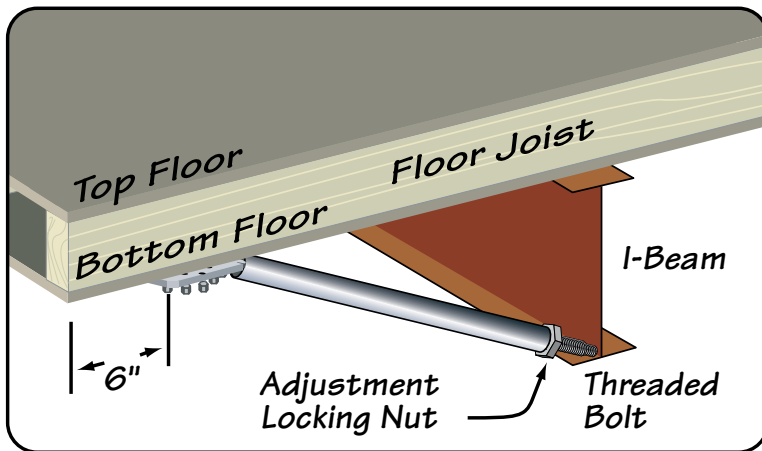

1. Determine floor joist area needing support.
2. Set mounting plate on floor joist and secure with 5 (#12X2") screws provided. Approx. 6" from outer rim joist.
3. Insert threaded adjuster bolt in support tube so it clears I-beam flange when mounting Plate is inserted and chisel end is placed against the frame. If support tube is too long, simply cut square to desired length.
4. Raise floor joist with jack to desired level before tightening the nut on the threaded bolt, snug fit to 1/4 turn past.
5. Replaces perimeter piers required for window and door support and alignment except as required by the home manufacturer for larger openings.
6. Built to Federal Manufactured Home & Safety Standards, for maximum openings up to 6' for 20lb. roof load, 4' for a 30 lb. roof load or 3' for a 40 lb. roof load per set of adjustable outrigger.
7. Outriggers can be used on openings up to 8' wide on roof loads up to 30 lb. when 2 outriggers are placed on each side of the opening. Place 1 outrigger on the first floor joist inside the opening and 1 outrigger on the first joist outside the opening. If the wall jamb falls directly over a joist, place 1 outrigger on that joist and the other one on the first floor joist inside the opening.
8. Installation of each outrigger should be in accordance with these instructions within 3' of a pier support or standard outrigger.

Do not use on homes while being transported.

Note: This component is not designed or intended to replace any foundation supports required by The home's manufacturer and is not a repair for damaged joists. These instructions address the capacity of the adjustable outrigger only.

Steel Support Pier Installation Instructions

Please refer to the Installation instructions provided by the manufacturer, and /or State and local regulations as to the pier placement and beam spacing. Check specific load requirements for footings and pier pads along with wind zone requirements for new or used manufactured units. Steel Support Piers are designed for use as a replacement for dry stacked blocks, piers available up to a maximum of 30 inches.

1. After the unit has been put in place and leveled with the appropriate safety equipment, begin placing the piers under the main beams at manufacturers specified distance.
2. Center the Pier on the footing or pad using fasteners (4 #14 X 2" screws if required) tighten pier head with 3/4" nut below pier top so the head is tight against the beam. Part 3285.304 of the new HUD installation rule specifies that "Manufactured pier heights must be selected so that adjustable risers do not extend more than 2" when finally positioned".

Steel Support Piers are designed and tested to vertical loads for a support rating of 6,000 lbs. Support Piers can be used under factory built structures such as manufactured homes, mobile commercial units, classrooms, multiplexes, sheds and other similar structures. They can be used in all wind zone conditions, except "Exposure D" within 1500 ft. of the coastline. Support piers are designed for use with a variety of heads to prevent movement after attachment to the beam or screwed to the marriage line; check local codes and manufacturers requirements for proper installation regulations for beam and marriage line installation.

When all Support Piers are installed, remove your safety equipment and go to the next step in set up.

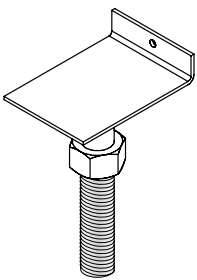

"L" Top Head
Part #MPH01

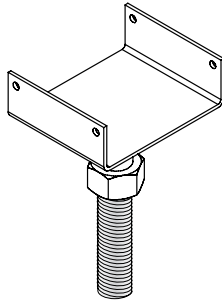

Saddle Top Pier Head
Part #MPH02

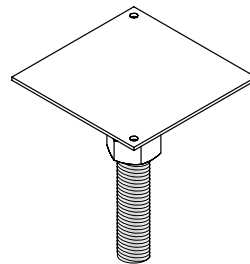

Flat Top Pier Head
Part #MPH04

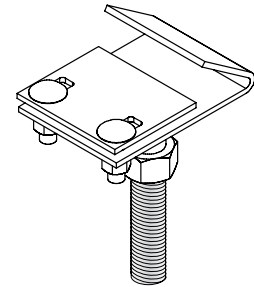

Beam Hook Top Pier Head
Part #MPH06

Steel Support Piers- 6,000 lb. Capacity Listing #BSK1050

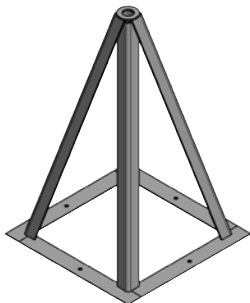

MH Support Pier	
8"	MPP8
10"	MPP10
12"	MPP12
14"	MPP14
16"	MPP16
18"	MPP18
20"	MPP20
22"	MPP22

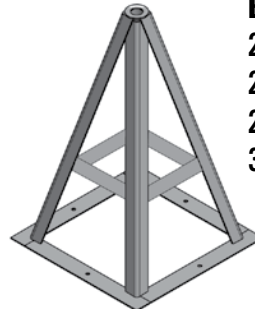

Braced MH Support Pier	
24"	MPP24
26"	MPP26
28"	MPP28
30"	MPP30

Propane Tank Anchorage Installation

The values represented here are for anchorage of submerged tanks. The uplift is due to the water table pushing the tanks up when the water reaches the depth of the tanks.

Tank Number	Water Capacity (Gal)	Leg Spacing (inches)	Dia. (in)	Length (inches)	Length (feet)	Surface Area (ft ²)	Weight Empty (lb)	Buoyancy Force (lb)
1	1990	192	48	287	23.92	95.67	3400	18231
2	1450	139.5	48	208	17.33	69.33	2658	13104
3	1000	121	41	192	16.00	54.67	1760	9110
4	850	86	41	165	13.75	46.98	1440	7800
5	500	60	37	119	9.92	30.58	949	4486
6	325	60	30	119	9.92	24.79	597	2936
7	250	60	30	94	7.83	19.58	483	2235
8	150	60	24	84	7.00	14.00	314	1317
9	120	45.25	24	80	6.67	13.33	257	1047
10	120	-	54	30	-	11.25	260	1044

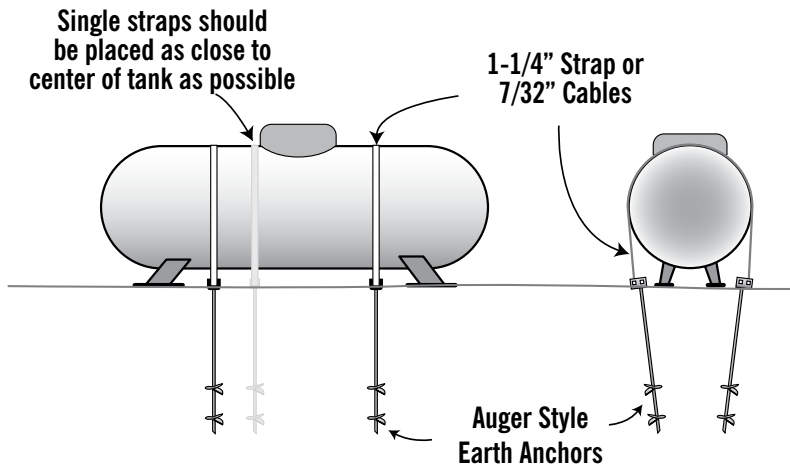

NOTE: Loading for strap and cable conditions is based upon 3150 lb. Working Load Capacity.

WARNING: Always check for underground utilities before installing

Strap: 1-1/4" X .031 Galvanized Steel, Class B, Grade 1, 4725 Tensile Strength.

Cable: 7/32. 7 x 19 Galvanized Cable, 5600 lb. Breaking Strength, 2 Anchors Required for Each Strap or Cable.

Tank Number	Wind Anchorage*									Buoyancy Anchorage*		
	100 mph.	110 mph.	120 mph.	130 mph.	140 mph.	150 mph.	160 mph.	170 mph.	180 mph.	# Cables Required	# Straps Required	Anchor Pull Out
1	0	0(2)	0(2)	0(2)	1(2)	1(2)	2	2	3	6	6	1546 lbs.
2	0	0	0(2)	0(2)	1(2)	1(2)	2	2	3	5	5	1577 lbs.
3	0	0	0	1(2)	1(2)	1(2)	2	2	3	4	4	1359 lbs.
4	0	0	0	1	1(2)	1(2)	2	2	3	3	3	1540 lbs.
5	0	0	0	1	1	1(2)	2	2	3	2	2	1359 lbs.
6	0	0	1	1	1	1	2	2	3	1	1	884 lbs.
7	0	0	1	1	1	1	1(2)	2	3	1	1	1359 lbs.
8	0	1	1	1	1	1	1(2)	1(2)	2	1	1	816 lbs.
9	1	1	1	1	1	1	1	1	2	1	1	653 lbs.
10	0	1	1	1	1	1	1	1	1	1	1	653 lbs.

NOTES:

- * Engineering data based on weight of a empty tank.
- (2) - 2 straps or cables recommended for stabilization on longer tanks in high winds.
- Eye or mobile home anchors must have a minimum of 5/8" shaft.
- Class 2 Soils require minimum of 30" anchor with (2) 4" disc.
- Class 3 Soils require minimum of 34" anchor with (1) 6" disc.
- Class 4A Soils require minimum of 48" anchor with (1) 6" disc.
- Class 4B Soils require minimum of 60" anchor with (1) 6" disc.



Emergency Spring Hanger Kits

For temporary replacement of broken spring hangers or additional axle installation when needed in the field. Kits available with 4 or 8 bolt front brackets for differing trailer types and weights. Spring not included. Plates are adjustable for 3" or 4" I-Beams. Not intended for use over 45 mph.

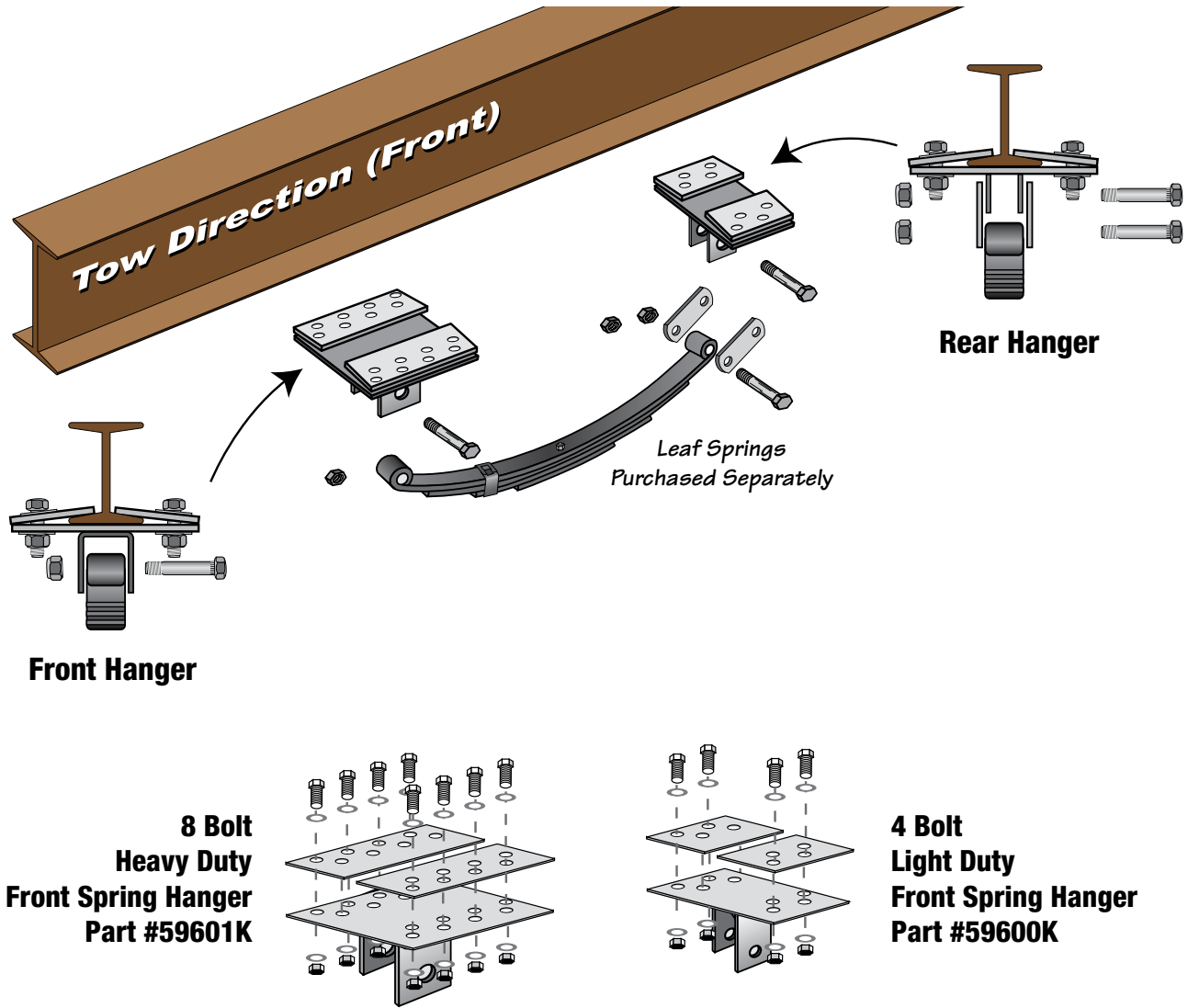

Installation Instructions

When adding an axle, begin by attaching the larger bracket to the I-Beam towards the front of the unit and leave bolts loose so the bracket can slide on the beam. The spacing for the hangers is generally 1/2" shorter than the distance between the "eyes" of the spring. Attach the smaller bracket behind the larger one with shackle links installed and leave the bolts loose so this bracket can slide on the beam. Follow these same steps and install the brackets to the beam on opposite side. Position axle under brackets and start by attaching rear of leaf springs to shackles on both sides with shackle bolts and snug but do not tighten. Install front of leaf springs to the large spring hangers and adjust spring and shackles to fit. Tighten all bolts at this time, making sure the bolts on the I-beam are tight.

Web Site Information



TIE DOWN ENGINEERING has over 600,000 sq. ft. of manufacturing facilities servicing 6 product divisions. The tiedown.com web site is divided into the six different product divisions and Manufactured Housing is the second largest division.

We try to include everything possible about manufactured housing as we can. All available information is located in the Manufactured Housing Division site at www.tiedown.com.



Download Library - Installation instructions (non state specific) including foundation systems, anchor installation and general instructions for Manufactured Housing.

State Approvals and State Instructions - Simply click on your state and see any state specific approval letters for foundation systems, anchors, pads & state specific installation instructions.

Test Reports - All available test reports for TDE manufactured housing products. Reports are listed in one convenient PDF catalog. Simply click on the test report you need and the report will automatically download to your computer. Test Report Data is password protected and access is given by calling Tie Down Customer Service.

Wind Zone Map - Wind Zone Comparisons (HUD's MHCSS and FEMA 85)



On Line -Manufactured Housing Products Catalog

All TDE manufactured housing products are included with purchase quantities. Listed beside each product (if available) is a PDF icon which when clicked will automatically download the instructions to your computer.



TIE DOWN ENGINEERING

**255 Villanova Drive SW • Atlanta, Georgia 30336
800-241-1806 • 404-344-0000 • Fax 404-349-0401**

ISO 9001:2008 Certification

**Trade, brand, names and drawings are the intellectual property of
TIE DOWN ENGINEERING.**

©2015 TIE DOWN, Inc.

Manual #08235 Revised 5/7/15